

Modeling and Calculating the In-Rush Currents in Power Transformers ¹

Abdolmutaleb Abou-Safe²

Gordon Kettleborough³

Abstract

This paper presents a mathematical model for an unloaded saturated transformer and predicts the in-rush current when the transformer is connected to the power supply. The model uses non-linear core parameters (R_0 and L_0), which vary according to the magnetic state and properties of the non-linear core.

The results of this research show the risks of connecting an unloaded power transformer to the power system. It is recommended that this phenomenon is taken into account when protection devices on the transformer are adjusted, to avoid mal-operations and consequent tripping of the transformer circuit breaker.

A comparison between experimental and simulated results, shows a good agreement and prove the validity of the model for detailed study of in-rush current phenomenon.

¹ For the paper in Arabic see pages (207 -208).

² Power Engineering Department, FMEE , Damascus University.

³ Electronic and Electrical Engineering Department, Loughborough University,U.K.

1.Introduction

Power transformers are essential components in power systems, and knowledge of their performance is fundamental in determining system reliability. Although attention usually concentrates on overload and short-circuit current calculations, a potentially disruptive transient condition may occur when an unloaded transformer is connected to the power system. Under certain conditions, a transient in-rush current several times the rated value [1,2] may result in the mal-operation of overload/fault relays with the consequent disconnection of the transformer from the power system [3,4]. The phenomenon is usually observed when a lightly loaded transformer is connected to the supply.

There are many references in the literature to this phenomenon, but few of them estimate the magnitude of in-rush current. Although present regulations do not require the calculation of in-rush current, its accurate determination is desirable to predict potential problems when switching-on an unloaded transformer.

This paper presents a mathematical model for a power transformer, which is capable of predicting in-rush current and uses parameters which vary according to the changing magnetic state of the transformer. Experimental characteristics were obtained using a 1.5 kVA, 240 V, 50 Hz transformer and these compare favorably with those obtained using the mathematical model.

2. Transformer in-rush transients

The transient electromagnetic state of a transformer connected to the power supply depends on factors such as the instant of switching-on the supply voltage, the residual core flux and the ratio between the core magnetizing inductance L_0 and the core loss resistance R_0 [5,6].

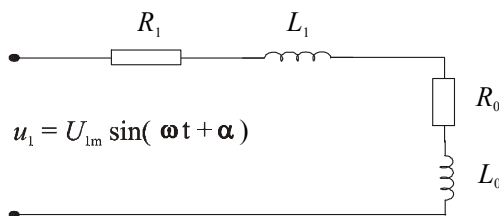

Figure1. Equivalent circuit for an unloaded transformer

The magnetizing inductance L_0 and core loss resistance R_0 may be represented as series impedances as shown in figure 1, with R_1 and L_1 representing respectively the primary winding resistance and leakage inductance.

Assuming the transformer supply voltage has a sinusoidal waveform $u_1 = U_{1m} \sin(\omega t + \alpha)$, the no-load in-rush current is defined by the first order differential equation

$$L \frac{di_0}{dt} + R i_0 = U_1 \sin(\omega t + \alpha) \quad (1)$$

where i_0 is the instantaneous no-load current, $L = L_1 + L_0$ and $R = R_1 + R_0$.

Equation (1) cannot be determined analytically due to the nonlinearity of the magnetizing inductance L_0 . Thus the equation should be re-written as a function of the magnetic core flux Φ . The relationship between the no-load current i_0 , the magnetizing inductance L_0 and the flux is:

$$L_0 i_0 = N_1 \Phi \quad (2)$$

where N_1 is the number of primary turns.

Substituting equation (2) in equation (1) gives

$$N_1 \frac{d\Phi}{dt} + N_1 (R/L) \Phi = U_{1m} \sin(\omega t + \alpha) \quad (3)$$

Assuming L is constant, equation (3) is a linear differential equation with constant parameters. The solution may be written as a function of the flux in the form

$$\Phi = \Phi_p + \Phi_a \quad (4)$$

where: $\Phi_p = \Phi_m \sin(\omega t + \alpha - \varphi)$ is the periodic component of flux.

The maximum amplitude Φ_m may be calculated from:

$$\Phi_m = U_{1m} / \omega N_1 \quad (5)$$

In general $R \ll \omega L$ and it may be assumed that $\varphi = \tan^{-1} \omega L / R \approx 90^\circ$.
Thus

$$\Phi_p = -\Phi_m \cos(\omega t + \alpha) \quad (6)$$

The transient component of the flux Φ_a is an exponentially decaying function:

$$\Phi_a = C e^{-(R/L)t}$$

The constant C comprises two components; the residual core flux $\pm \Phi_r$, which in some cases may approach 50% of component Φ_m [5], and a component which negates the periodic component at the instant $t = 0$. Thus $C = \Phi_m \cos \alpha \pm \Phi_r$ and

$$\Phi_a = (\Phi_m \cos \alpha \pm \Phi_r) e^{-(R/L)t} \quad (7)$$

The final form of the resultant transient is

$$\Phi = -\Phi_m \cos(\omega t + \alpha) + (\Phi_m \cos \alpha \pm \Phi_r) e^{-(R/L)t} \quad (8)$$

Equation (8) shows that the transient value of the magnetic flux depends on the supply voltage phase angle α at the instance of switching, and on the residual flux value Φ_r . If $\alpha = \pi/2$ at the instance of connection and Φ_r is 0, the resultant flux will settled instantly at its steady- state periodic value $\Phi = \Phi_m \sin(\omega t)$ and the current in the transformer takes

its nominal no-load value. Alternately, if $\alpha=0$ and $\Phi_r = 0.5\Phi_m$, the magnetic flux may approach $\Phi \approx 2\Phi_m + \Phi_r$ [7,8], after half a cycle.

This case leads to excessive core saturation, which results in a considerable reduction in the transformer impedance and the current may be several hundred times its nominal no-load value as shown in figure 2. The in-rush current appears to protection devices as a fault current and may cause the circuit breaker to trip [3,9].

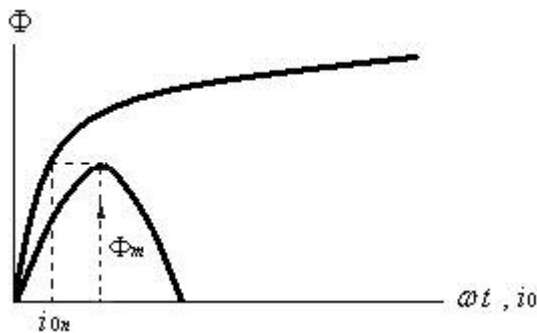

Figure 2. Flux / no-load current characteristic

Equation (2) may be used to determine the steady- state no-load current i_0 of an unsaturated transformer, where constant L gives

$$i_0 = N_1 \frac{\Phi}{L} \quad (9)$$

However, in a transient condition, both R_0 and L_0 may change rapidly according to the magnetic state of the core laminations and the initial values of α and Φ . Therefore both R_0 and L_0 should be re-calculated as time functions of the transformer magnetic field.

L_0 is calculated as:

$$L_0 = \Lambda_0 N_1^2 = \mu_0 \mu_r \frac{A}{l} N_1^2 \quad (10)$$

where- Λ_0 is the core magnetic permeance [Wb/A]; μ_0, μ_r respectively the permeability of free space [Wb/Am] and the relative permeability; A is the cross sectional area of the magnetic core [m²] and l is the equivalent length of the magnetic circuit [m].

The relative permeability is determined using the magnetization curve $B = f(H)$:

$$\mu_r = \frac{B}{\mu_0 H} \quad (11)$$

The magnetic flux density is

$$B = \frac{\Phi}{A} \quad (12)$$

L_0 changes from its steady-state (maximum) value to some transient value L'_0 in accordance with the ratio

$$\frac{L_0}{L'_0} = \frac{\mu_0 \mu_r \frac{A}{l} N_1^2}{\mu_0 \mu'_r \frac{A}{l} N_1^2} = \frac{\mu_r}{\mu'_r} \quad (13)$$

Thus the transient value of the inductance is

$$L'_0 = L_0 \frac{\mu_r}{\mu'_r} \quad (14)$$

The core- loss resistance R_0 varies with saturation and its transient value R'_0 may be determined from

$$\frac{R_0'}{R_0} = \frac{\frac{P_0'}{i_0'^2}}{\frac{P_0}{i_0^2}} = \frac{P_0' i_0^2}{P_0 i_0'^2} \quad (15)$$

where P_0 is the steady-state core loss. Assuming this value is proportional to flux density squared, the core loss change from P_0 to P_0' when the flux density changes from B_0 to B' is

$$\frac{P_0'}{P_0} = \frac{B_0^2}{B'^2}$$

Thus the transient core loss is

$$P_0' = P_0 \frac{B'^2}{B_0^2} \quad (16)$$

Assuming $L \approx L_0$ the current change may be determined from the ratio

$$\frac{i_0'}{i_0} = \frac{N_1 \frac{\Phi_0'}{L_0}}{N_1 \frac{\Phi_0}{L_0}} = \frac{\Phi_0' L_0}{\Phi_0 L_0} = \frac{B_0' L_0}{B_0 L_0} = \frac{B_0 \mu_r'}{B_0 \mu_r}$$

giving

$$i_0' = i_0 \frac{B_0 \mu_r'}{B_0 \mu_r} \quad (17)$$

Substituting equations (1-16) and (1-17) in equation (1-15) gives

$$R_0' = R_0 \frac{B_0^4 \mu_r'^2}{B'^4 \mu_r^2} \quad (18)$$

Since R_0 and L_0 reduce considerably in the transient condition, the primary winding resistance R_1 and leakage inductance L_1 must be taken into account. Thus the equivalent transient resistance and inductance of the transformer are respectively

$$R = R_0' + R_1 \quad \text{and} \quad L = L_0' + L_1 \quad (19)$$

and the transient flux is

$$\Phi = -\Phi_m \cos(\omega t + \alpha) + (\Phi_m \cos \alpha \pm \Phi_r) e^{-(R/L)t} \quad (20)$$

Using the above analysis, the computer program shown in block diagram form in figure

3 was written. To insure high accuracy, small integration step of 0.001 s was used.

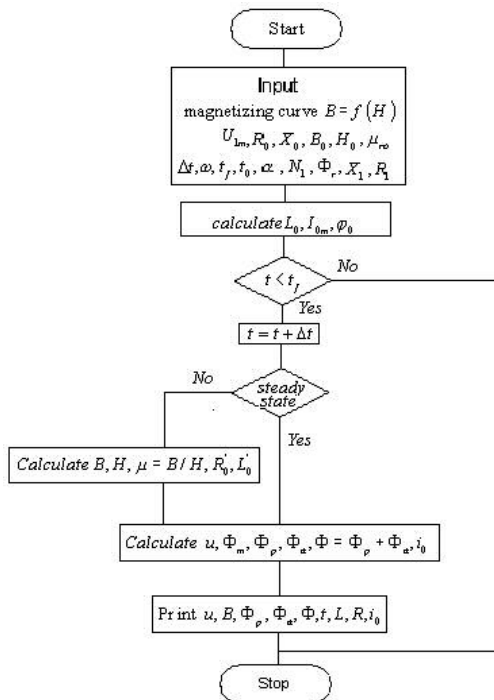

Figure.3. The block diagram of computing program

A numerical study of transformer in-rush current was undertaken using a 2500 kVA transformer, which is typical of that used in textile plants in Syria. The transformer has the following specifications and test data: Type- UTHC-2500, $S_n=2500$ kVA, $U_{1n}=20$ kV, $U_{2n}=0.41$ kV, $I_{1n}=72.2$ A, $I_{2n}=3520.5$ A, vector group D/yn-11, $I_0=0.63$ A, $P_0=3.31$ kW, short-circuit primary voltage $U_{sc}=1467$ V, full-load copper loss $P_{sc}=23$ kW, equivalent windings impedance referred to the primary $Z_{Te}=35.2 \Omega$, winding resistance referred to the primary $R_{Te}=4.4 \Omega$, primary impedance $Z_{1n}=479.3 \Omega$. As the specification does not contain information on core laminations, it is assumed that the core is made of M-19 steel, which is typical for transformers of such ratings.

Using the factory no-load test data the steady parameters are

$$Z_{T0ph} = U_{0ph} / I_{0ph} = 20000 \cdot \sqrt{3} / 0.63 = 54920.6 \Omega$$

$$R_{T0ph} = P_{0ph} / I_{0ph}^2 = 3310 / 0.63^2 = 8339.6 \Omega$$

$$X_{T0ph} = \sqrt{Z_{0ph}^2 - R_{0ph}^2} = \sqrt{54920.6^2 - 8339.6^2} = 54283.7 \Omega$$

With nominal supply voltage of 20 kV and assuming a residual core flux Φ_r at the moment of connection of 50% nominal ($\Phi_r = 0.0225$ Wb), the resulting of in-rush transient for $\alpha = 0$ is shown in figure 4.

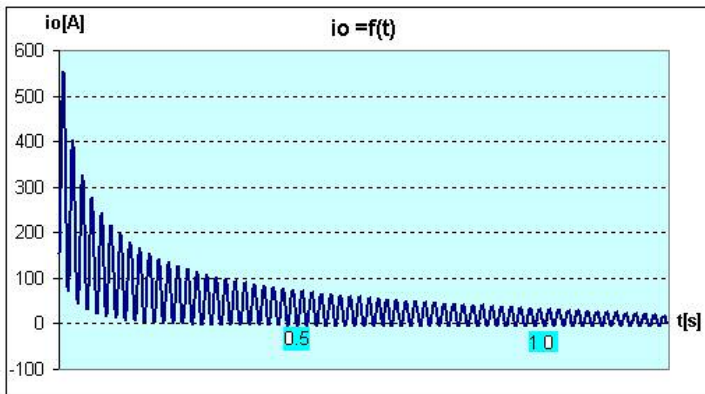
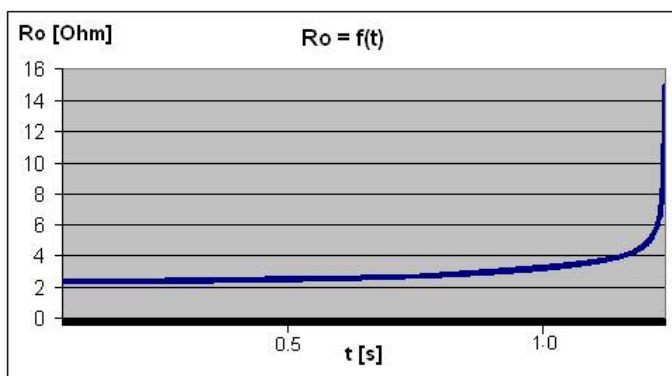
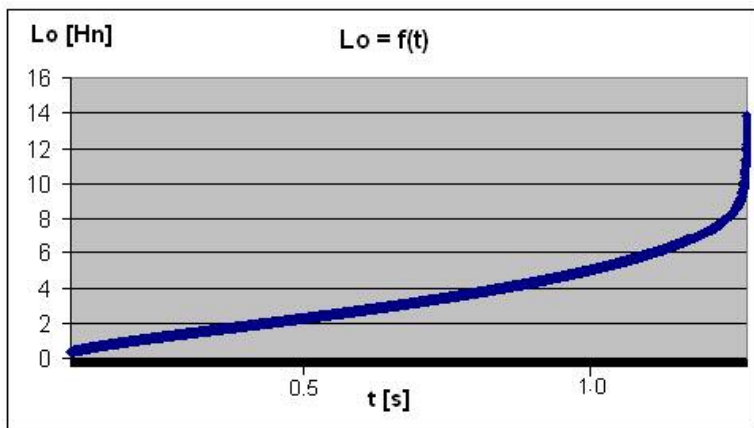

Figure.4. In-rush current of the transformer UTHC-2500 kVA with $\alpha = 0$.

The peak in-rush current of 554 A is about seven and half times the rated load current, which decays to its no-load value in 1.5 s. Comparing these results with similar experimental results [2,3,4] shows that the peak in-rush current varies between four and ten times the rated load current, depending on the transformer ratings and its magnetic core specifications. The transient decay is typically 1.2-1.5 s.



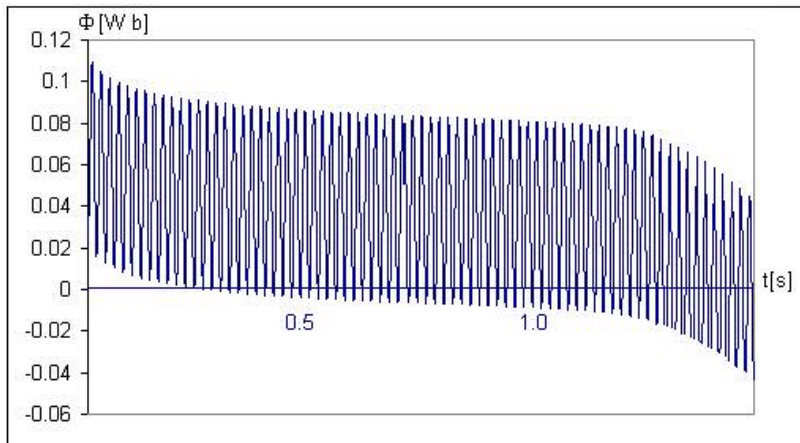

Figure.5.Theoretical variation of L_0 , R_0 and core flux for $\alpha = 0$.

Figure.5 shows the appreciable effect of saturation on L_0 and R_0 . Initially they are small and the resulting transformer impedance consists mainly of the primary winding impedance R_1+jX_1 . As the transient progresses, L_0 and R_0 increase until they eventually assume their normal values. Initially they increase slowly then more rapidly as they approach their steady state unsaturated values. The non-linear properties of the core also appear in the magnetic flux, where it is observed that it decays slowly during heavy saturation, then rapidly during the last stage of the transient as it approaches its nominal value. The peak flux in this case is about 2.5 its nominal value, which confirms the theoretical concepts of this phenomenon.

The accuracy of prediction of the proposed model was compared with that obtained using Matlab software package 6.5. The transient was simulated using a set of elements from the Matlab library including a three-phase two-winding saturable transformer of the same specifications, three single-phase sinusoidal voltage sources each of 16400 V , measuring and displaying devices to monitor the in-rush current and voltage waveforms as shown in figure 6.

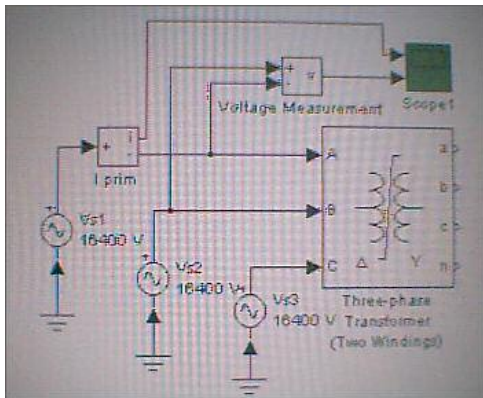

Figure.6. Transformer in-rush current simulation using Matlab software

Figure 7 shows the Matlab simulation results and these compare favourably with those obtained using the proposed model. The peak value of in-rush current obtained using the Matlab simulation is 610 A, which is about 8 times the nominal full load current. The difference in the in-rush current values calculated by the proposed model and those obtained from Matlab simulation is probably due to the difference in the magnetizing characteristic used in each method

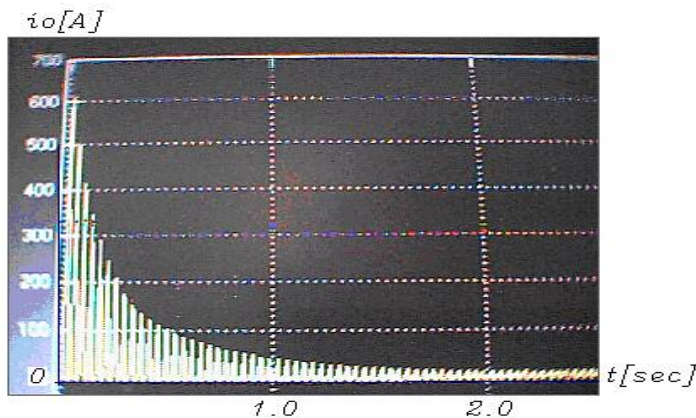

Figure.7 Matlab simulation for power transformer UTHC-2500 kVA with $\alpha_0 = 0$ and $\Phi_r = 0.5\Phi_m$.

As further verification for the proposed model , an experimental study was undertaken on a single-phase laboratory transformer type EMTU-TTO1, having the following specifications: $S_n=1500$ VA , $U_{1n}=240$ V , $U_{2n}=240$ V, $I_{1n}=6.25$ A , $I_{2n}=6.25$ A.

The following results were obtained from no-load and short-circuit tests: $U_0=U_{1n}=240$ V , $I_0=0.123$ A , $P_0=15$ W, short-circuit primary voltage $U_{sc}=48$ V, $P_{sc}=97.5$ W, $I_{sc}=I_{1n}=6.25$ A.

These results gave the following equivalent circuit parameters:

$$\begin{aligned} Z_0 &= U_0 / I_0 = 240 / 0.123 = 1951.2 \Omega \\ R_0 &= P_0 / I_0^2 = 15 / 0.123^2 = 991.5 \Omega , \\ X_0 &= \sqrt{Z_0^2 - R_0^2} = \sqrt{1951.22^2 - 991.47^2} = 1680.6 \Omega , \\ Z_{s.c} &= U_{s.c} / I_{s.c} = 48 / 6.25 = 7.7 \Omega \\ R_{s.c} &= P_{s.c} / I_{s.c}^2 = 97.5 / 6.25^2 = 2.5 \Omega , \\ X_{s.c} &= \sqrt{Z_{s.c}^2 - R_{s.c}^2} = \sqrt{7.68^2 - 2.5^2} = 7.3 \Omega . \end{aligned}$$

The B/H magnetizing characteristic for the transformer was obtained from the no-load test for various values of no-load current and corresponding no-load voltage. The equations used for determining values of B and H are :

$$U_0 = 4.44 f B A T_f K_w \quad (21) ,$$

$$i_0 T_f = H l \quad (22)$$

where the power supply frequency $f = 50$ Hz; the cross sectional area of the core $A = 12.5 \times 10^{-4} m^2$; $K_w = 0.95$; the average core length $l = 0.45 m$.

From equation (21) ,

$$B = \frac{U_0}{4.44 f A T_f K_w}$$

and from equation (22)

$$H = \frac{i_0 T_f}{l}$$

The resulting B/H characteristic is shown in figure 8.

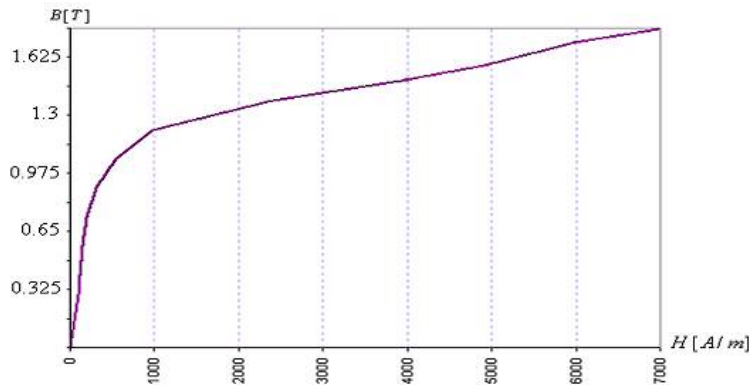

Figure 8. Experimental magnetizing characteristic for laboratory transformer EMTU-TTO1

Using the magnetizing characteristic of figure 8, the in-rush current for the test transformer was determined using the new model, when the supply voltage phase angle $\alpha = 0$. The resulting transient is shown in figure 9. The peak in-rush current is 35.3 A, which is about 6 times the nominal load current. The transient decays during the relatively short time of about 0.25 sec, which may be explained by the high ratio of R_0 to X_0 in a small transformer. On the other hand, the peak magnetic flux is 0.0054 Wb, which is about 2.5 its nominal value. Its aperiodic component decays within the same decaying time as the in-rush current.

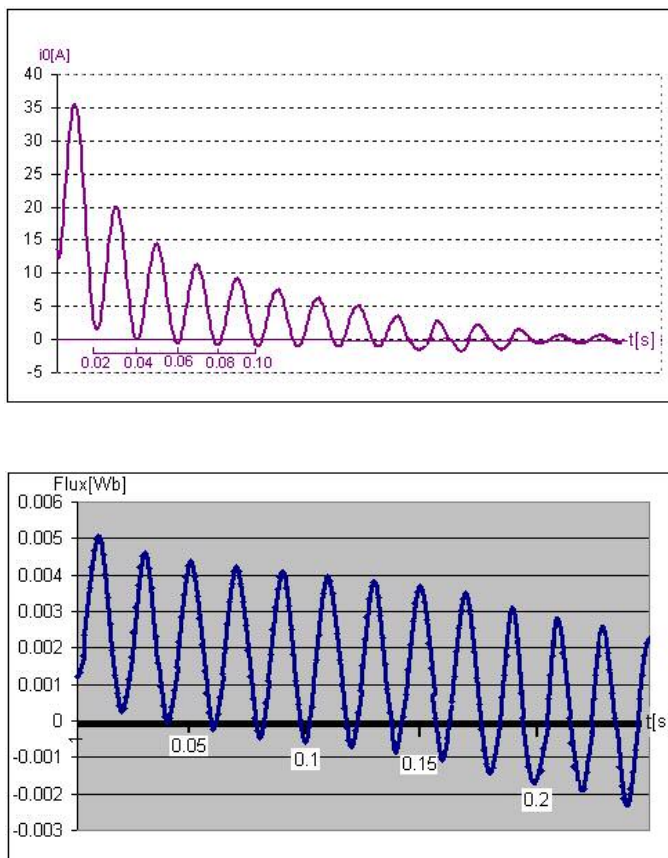

Figure.9.Simulated in-rush current and magnetic core flux for the laboratory transformer ($\alpha = 0^\circ$).

The experimental in-rush current for the laboratory transformer, with $\alpha = 0^\circ$ is shown in figure10. The peak value of the inrush current is about 36 A, and the transient decays in about 0.25 sec.

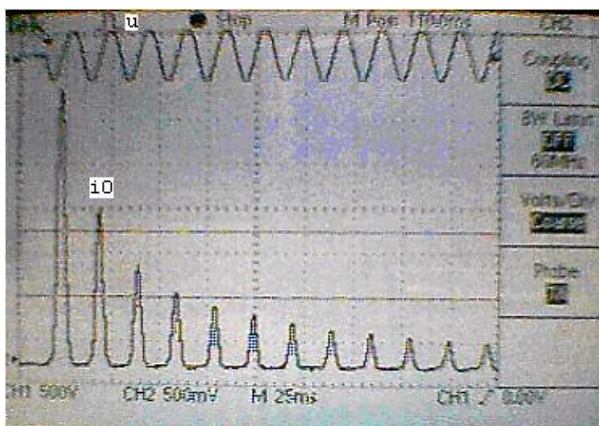

Figure.10. Experimental in-rush current for the laboratory transformer ($\alpha = 0$).

A simulation of the laboratory transformer connected to the power supply at $\alpha = 90^\circ$ is shown in figure 11. As expected, the current in this case settles immediately to its steady state value.

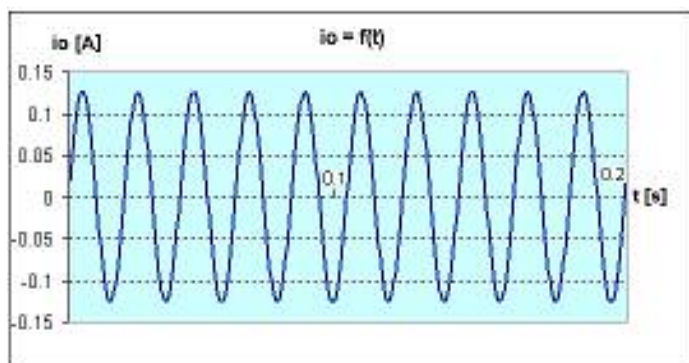

Figure.11. Simulated in-rush current for the laboratory transformer ($\alpha = 90^\circ$).

The experimental result for this condition is shown in figure12 and again, it is observed that the transient is negligible and the current instantaneously assumes its steady-state value of 0.13 A.



Figure.12.Expermental in-rush current for the laboratory transformer ($\alpha \approx 90^\circ$).

Conclusions:

This paper presents a mathematical model for an unloaded saturated transformer and predicts the in-rush current when the transformer is connected to the power supply. The model uses non-linear core parameters (R_0 and L_0), which vary according to the magnetic state of the non-linear core.

A comparison between experimental and simulated results, shows a good agreement and proves the validity of this model for studying in-rush current.

The results of this research show the risks of connecting an unloaded power transformer to the power system. It is recommended that this phenomenon is taken into account when protection devices on the transformer are adjusted, to avoid mal-operations and consequent tripping of the transformer circuit breaker.

References

- [1] D.A. Koppikar, and others. A modified approach to overfluxing analysis of transformers. *Electrical Power &Energy Systems*, Vol. 20, No.4, pp. 235-239, Elsevier Science Ltd.1998.
- [2] Michael Steurer and Klaus Fröhlich, "The Impact of Inrush Currents on the Mechanical Stress of High Voltage Power Transformer Coils," *IEEE Trans. On Power Delivery*, vol. 17, no. 1, pp. 155–160, January 2002.
- [3] Moises Gomes-Morante and Denise W. Nicoletti. , "A Wavelet based Differential Transformer Protection," *IEEE Trans. On Power Delivery*, vol. 14, no. 4, pp. 1351–1358, October 1999.
- [4] Smith, K.S. Ran and L. Leyman, B. , "Analysis of transformer inrush transients in offshore electrical systems," *IEEE Proceedings on Generation, Transmission and Distribution*, vol. 146, no. 1, pp. 89–95, January 1999.
- [5] Brusekin A. and others. *Electrical machines and micro machines.*" High school" publications, Moscow, 1990.
- [6] J. Jesus Rico, Enrique Acha, and Manuel Madrigal, "The Study of Inrush Current Phenomenon Using Operational Matrices," *IEEE Trans. On Power Delivery*, vol. 16, no. 2, pp. 231–237, April 2001.
- [7] Karen L. Butler-Purry, and Mustafa Bagriyanik, "Characterization of Transients in Transformers Using Discrete Wavelet Transforms," *IEEE Trans. On Power Systems*, vol. 18, no. 2, pp. 648–656, May 2003.
- [8] Philip Kiameh. *Electrical equipment handbook* . McGraw-Hill Book Co., New York,2003.
- [9] H. Zang, J.F. Wen and others. Discrimination between fault and magnetizing inrush current in transformers using short-time correlation transform. *Electrical Power &Energy Systems*, Vol. 24, pp. 557-562, Elsevier Science Ltd.2002.

Received, 3 June, 2004.